

BAHIA

Rigging Manual

- 1** Glossary
- 2** Sail Numbers
- 3** Rigging and Raising the Mast
- 4** Boom and Gnav
- 5** Sails
- 6** Lower Shroud Tensioning
- 7** Gennaker
- 8** Mainsail
- 9** Outhaul
- 10** Cunningham
- 11** Single Line Reefing
- 12** Single Line Reefing Instructions
- 13** Single Line Reefing Method
- 14** Rudder and Centerboard
- 15** Launching, Rowing, Engine Use and Basic Safety on the Water
- 16** Engine, Bracket and Storage Box (Optional extra)
- 17** Maintenance and Service

BAHIA Rigging Instructions

The Bahia rigging instructions are a guide to rigging your boat. LaserPerformance reserves the right to make design and/or specification changes to any of their products as part of their continuous development program.

Important information

There are three hatches and one transom drain bung on the Bahia. They all should be checked to ensure a correct and watertight fit, every time you sail.

1. Starboard side (right) on the foredeck recess forwards of the main beam. (figure 1)



figure 1

2. Center console area between the hoop. This is a watertight compartment for keys, mobile, wallet etc and is not part of the buoyancy of the boat. (figure 2)



figure 2

3. Aft cockpit. (figure 3)

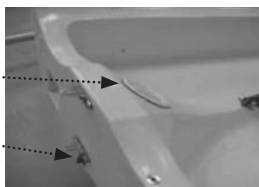

figure 3

4. Transom drain bung must also be checked prior to launch. (figure 3)



Warning: The mast head flotation device (optional extra) is an aid to the buoyancy of the masthead in the event of your sailing craft capsizing. However, it may not stop the total inversion of your craft and should not be relied upon to do so. LaserPerformance cannot accept any liability in such a case.



1. Glossary

Aft: Rearward
Batten: A thin stiffening strip in the sail to support the leach
Boom: Spar at the bottom of the mainsail
Bow: Front of the boat
Burgee: Wind direction indicator (usually a small flag)
Cleat: A fitting used for holding/securing line
Clew: Back lower corner of a sail
Cunningham: Purchase system for tightening the forward edge/luff of the sail
Foot: Bottom edge of the sail
Fore: Forward
Forestay: The wire supporting the mast at the bow of the boat
Gennaker: Isometric sail hoisted when sailing downwind
Gennaker pole: The pole that extends from the bow to fly the gennaker sail
Gnav: Purchase system for tightening the rear edge/leach of the sail
Gudgeon: Fitting on the transom and rudder used to hang the rudder
Gunwale: The outermost edge of the boat
Halyard: A rope or wire used to lower or hoist sails
Head: Top corner of sail
Jib: Front sail

Leach: Rear edge of the sail
Luff: Forward edge of the sail
Mast: Main vertical spar supporting the rig/sails
Mast Heel: Fitting on the bottom edge/foot of the mast
Mast step: Fitting on the boat where the mast heel/foot of the mast is located
Outhaul: Purchase system for tightening the bottom edge/foot of the sail
Rudder: Blade and attachments used for steering the boat
Shrouds: Pieces of standing rigging which hold the mast up from side to side connecting at the top of the mast, with additional shrouds connecting partway down the mast. The shrouds then terminate at their bottom ends to the side of the boat. Shrouds are attached symmetrically on both the port and starboard sides.
Spreaders: Metal struts placed in pairs to support the mast side ways and control the bend in the mast
Stern: Back of the boat
Stem fitting: Stainless fitting at the bow to which the forestay attaches
Tack: Forward lower corner of sail
Vang: Otherwise known as the kicking strap, Gnav

2. Sail Numbers

Apply the sail numbers in a dry, clean and wind free environment using the following guidance:

1. Lay the sail on a flat surface starboard side up.
2. The numbers on the starboard side are always higher than the port side.
3. Measure 200 mm down from the second batten pocket from the bottom of the sail.
4. Mark a line parallel to the batten pocket. Use tape.
5. Measure 100 mm in from the leach on this line.
6. The first number is positioned 100 mm in from the leach and with the top of the number on this tape line.
7. The numbers are 60 mm apart.
8. Turn over the sail and position the port numbers 60 mm below the starboard numbers and parallel to them.



3. Rigging and raising the mast

1. Unpack the mast from its packaging.
2. Ensure all the halyards are led to the base of the mast and each halyard rope end has a knot tied in it. (figure 4)
3. Insert blanking plugs, (tight fit to produce seal) a medium size flat blade screwdriver maybe required to fit. (figure 5)
4. If applicable, fit trapeze wires and plugs in the top terminal positions on the mast. (Note: Trapeze kit is an option) (figure 6)
5. Fit spreaders

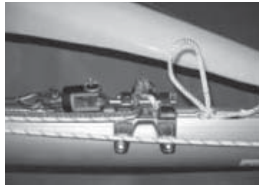

figure 4

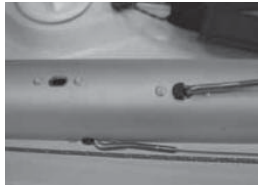
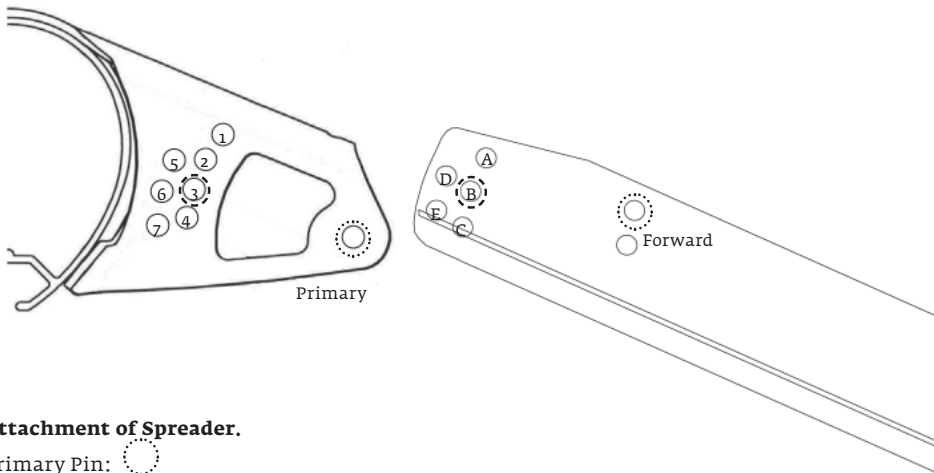

figure 5



figure 6



Attachment of Spreader.

Primary Pin: 
Fit down through the bracket's Primary hole and the Forward spreader hole.

Adjuster Pin: 
Fit down through bracket adjuster hole 3, and through spreader adjuster hole B.

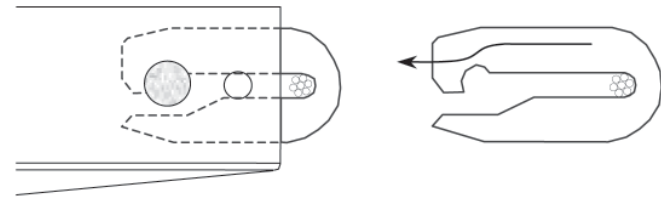

Spreader Ends

Remove the clevis pin and slide out the spreader end hook. Slide the hook over the shroud, and slide back into the spreader. Refit the clevis pin and split ring.

Class	Bracket Connection Pin	
	Primary	Adjuster
Bahia	Fwd	3B

Security

All clevis pins must be fitted with the flat head on top, and locked with a split ring. Tape all split rings, pins and the outboard end of the spreader extrusion. This will reduce chafe on the mainsail and prevent flailing sails/halyards becoming damaged. Self-amalgamating tape is best, but PVC electrical tape is an adequate alternative.

6. Ensure that all the spreader pins and rings are taped up or serious damage could occur to the sails. (figure 7a) (figure 7b)

7. Mast head float (optional extra).

- Stick the self adhesive neoprene strip to the top of the mast. This should be butted up to the top casting but not on the top casting. (figure 8)

- Place the mast head float onto the mast head. The lacing eyes are on the front of the mast head float and the front of the mast. Tie the mast head float onto the mast using the lacing eyes. (figure 9)

Warning: The mast head flotation device (optional extra) is an aid to the buoyancy of the masthead in the event of your sailing craft capsizing. However, it may not stop the total inversion of your craft and should not be relied upon to do so. LaserPerformance cannot accept any liability in such a case.

Note: This is a two person operation as someone will need to hold forestay - ensure that there are no overhead power cables.

8. Place the mast heel into the mast step and put the pin through the mast heel and fit the ring into the clevis pin (figure 10)

9. Attach the shrouds to the shroud anchor point with the adjuster pin position in the 4th hole down on the back of the vernier adjuster. No. 7 engraved on the adjuster. (figure 11)



figure 7a



figure 7b



figure 8

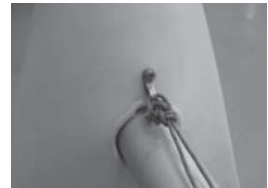

figure 9



figure 10

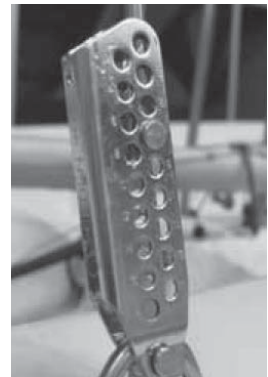

figure 11

10. Raise the mast with one person standing in the boat and one person pulling up the mast with the forestay. (figure 12)

Note: Always stand in the boat forward of the trolley wheels to stop the boat tipping up.

11. Temporarily attach the forestay around the jib tack bar (not the furling drum). (figure 13)

12. Shackle the lower shrouds to the shroud anchor points ensuring that a multiple thickness line of approximately 125 mm in rigged length is used between the shackle and the hard eye in the end of each lower shroud wire. The shackle should be positioned forward of the stay adjuster. (figure 14)

13. Loosely fasten the other end of the lower shroud wires to the eye on the front face of the mast using multiple thickness line. (figure 15)

Note: Lower shroud tension is adjusted using these line stops after the jib halyard has been tensioned. (figure 15)

14. Attach the trapeze rings to hull mounted shock cords by feeding the elastic loop through the ring at the bottom of the pulley. (figure 16)

Note: Trapeze kit is an option.

15. Place the loop of elastic shockcord over the metal trapeze ring and pull tight. (figure 17)



figure 12



figure 13

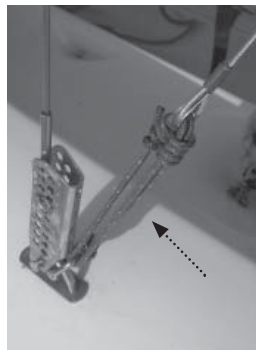

figure 14



figure 15



figure 16



figure 17

4. Boom and Gnav

1. Unpack the boom and Gnav tackle. (figure 18)

2. Attach the boom to the mast using the drop nose pin. (Articulating toggle at the bottom) (figure 19)

3. Tie the Gnav control line from the boom to the double block and becket at the base of the mast the boat. (figure 20)

Tip: Best practice would be to use a bowline.

4. Attach the Gnav strut to the Gnav anchor point using the drop nose pin. (Articulate toggle at the bottom with joint orientation as shown.) (figure 21)

5. Mainsheet - The mainsheet stops at the block on the top of the hoop with a stop knot and then threaded as shown. (figure 22a) (figure 22b)



figure 18



figure 19



figure 20



figure 21



figure 22a



figure 22b

5. Sails

1. Ensure furling drum line is fully wound completely onto furling drum before you attach the jib. (figure 23)
 2. Unroll the jib and attach jib tack to furling drum. Tape up pins on jib tack. (figure 24)
 3. Attach the head of the jib to the jib halyard furling swivel and tape up prior to hoisting. (figure 25)
 4. Hoist jib by pulling the white halyard out of aft face of the mast then hook the jib halyard purchase system onto jib halyard wire. (Ensure hook is facing aft.) (figure 26)
 5. Tension the jib halyard purchase system until the jib luff wire is taught. Cleat and tidy the rope end in the pocket on the underside of the gennaker sock. (If a loose gauge is used to measure the rig tension do NOT exceed 15 units or 70 kgs - measured on the shroud 0.75 meters above the vernier adjuster.) (figure 27)
 6. Tidy the halyards in the halyard bag. (figure 28)
 7. Attach the center of the jib sheet to the jib clew. (figure 29)
 8. Thread the free ends of the jib sheet through the jib fairlead cleats on the inner deck. (figure 30)
- Tip: A best practice would be to tie the sheet ends together to prevent flailing and inhibit sheets falling overboard. (figure 31)*
9. Remove the forestay from the jib tack bar and tie to the P clip at the bottom of the mast. (figure 32)
 10. Furl the jib by pulling the furling line. The furling line cleat is positioned on the front beam starboard hand side.

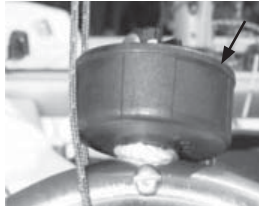

figure 23

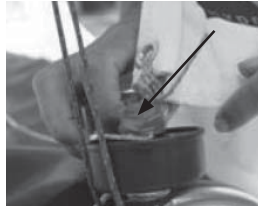

figure 24



figure 25



figure 26



figure 27



figure 28

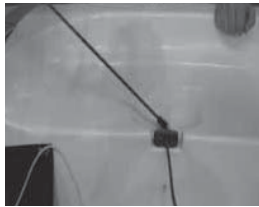

figure 29



figure 30



figure 31

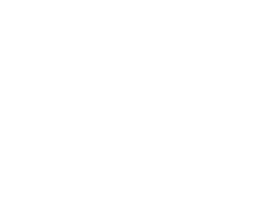

figure 32

6. Lower shroud tensioning

After tensioning the jib halyard readjust the lower shrouds so that they are just tight. **It is essential that the mast is straight** before the mainsail is hoisted (fore and aft and side to side). Lower shroud tension should be adjusted accordingly. (figure 33)

7. Gennaker

1. Temporarily tie the gennaker halyard to one of the lower shrouds. (Blue halyard exiting from $\frac{3}{4}$ height up mast, just above the jib halyard sheave box.)
 2. Ensure the end of the gennaker halyard taken from the base of the mast is free of knots and tangles. (figure 34)
 3. Feed the end of the gennaker halyard through the turning block at the base of the mast and feed forwards towards the bow. (figure 35)
 4. Locate the gennaker pole "out" rope under the Gennaker sock at the bow. This is a blue rope with a block at the end as shown. (figure 36)
 5. Pull out the pole to its full extension. (figure 37)
 6. Feed the pole "out" rope and block back down the shute towards the back of the boat. (figure 38)
- Note: This must go under the gennaker sock and ABOVE the pole webbing at the front of the shute.*
7. Fed the gennaker halyard through the pole "out" block under the sock. (figure 39)



figure 33



figure 34

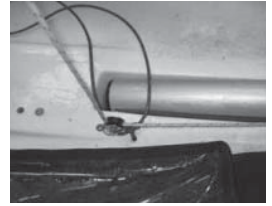

figure 35



figure 36



figure 37



figure 38

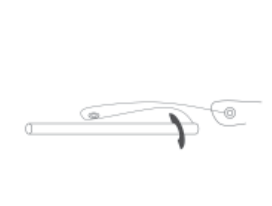

figure 39

8. Feed the gennaker halyard through the cleat on the starboard side of the centerboard case and then through the turning block (white rope shown). (figure 40)

9. Feed the halyard end over the toestraps and through the retrieval block on the starboard side. (figure 41)

10. The gennaker halyard then goes back up the shute to the bow. A batten or tiller extension is useful to feed this up the shute. (figure 42)

11. Unfold the gennaker:

A. Identify the tack (written on the sail).

B. Secure to the gennaker pole tack line to the sail using a bowline. (The tack line comes out of the front of the gennaker pole.)

C. The plastic bobble should be between the sail and the pole end. (figure 43)

12. Untie the gennaker halyard from the lower shroud and secure to the head of the gennaker using a bowline. (figure 44)

13. Take the end of the gennaker halyard from the jib tack bar (you previously passed through the sock). Pass the downhaul end of the gennaker halyard through the lower downhaul patch ring on the port side of the sail. (figure 45)

14. Secure to the upper downhaul patch using a bowline. (figure 46)

15. Attach the center of the gennaker sheet to the clew of the gennaker. (figure 47)

16. Pass the free ends of the gennaker sheets aft (one sheet either side of the jib luff) and through the gennaker sheet ratchet blocks attached to the anchor points. There are arrows on the ratchet block to indicate which way the rope should pass. When under load, the ratchet will engage. (figure 48)

Note: The sheets must pass outside of the shrouds and trapeze lines at all times.

17. Tie the free ends of the gennaker sheet together. (figure 49)

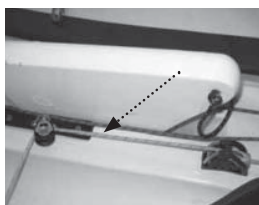

figure 40

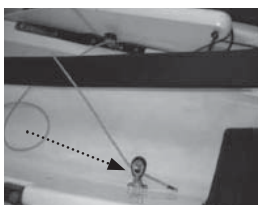

figure 41



figure 42



figure 43



figure 44



figure 45



figure 46



figure 47



figure 48



figure 49

18. Ensure the boat is pointing directly into the wind and hoist the gennaker. Take great care to ensure that the gennaker does not get snagged around the trolley; a second person should help with this to ensure it does not snag anywhere. Check to make sure the gennaker is not twisted and the sheets are not tangled with the halyard. **ALWAYS TAKE GREAT CARE TO PULL UP THE GENNAKER SLOWLY AND DO NOT KEEP PULLING IF IT BECOMES TANGLED OR TIGHT.** (figure 50)

19. Unclear the halyard and gently pull the gennaker into the sock by pulling the halyard through the block at the aft end of the sock. A second person should help with this and be positioned at the front of the boat to ensure the gennaker does not get snagged anywhere.

8. Mainsail

1. Remove the mainsail from the bag and unroll.

2. Ensure all battens are tight in their pockets and the velcro locking mechanisms are positively engaged:

A. To release the tension from a batten, slide the batten prodder (supplied) carefully between the two halves of the velcro locking mechanism and pull the retrieval line slowly (figure 51)

B. To adjust batten tension, place the tip of the prodder into the location point at the end of the velcro strip then insert it between the batten and the batten pocket's inner side. (figure 52)

Push the prodder until the desired batten tension is attained, then withdraw the prodder gently while pressing both sides of the batten pocket together to reengage the velcro locking mechanism.

3. Position the boat so that it is head to wind – bow into the wind.

4. Place the mainsail in the cockpit of the hull with the luff closest the bow (front) and the leach closest the stern (back).

5. Take the main halyard:

A. Ensure there is no twists in the halyard and it is clear of the spreaders.

B. Form a loop in the end of the halyard; pass the loop through the eye in the head of the mainsail. (Pass loop from starboard/right to port/left side)

C. Pass the bobble through this loop and pull tight to secure. (Ensure the bobble is positioned on port/left side as shown – this ensures the bobble will not get caught in the “V” between the Gnav bar and the mast during hoisting.) (figure 53)



figure 50



figure 51



figure 52



figure 53

6. Place the head of the mainsail into the mast track. The Gnav bar must be be on the starboard side of the sail with sail and halyard to the port side of the Gnav bar. (figure 54)



figure 54

7. Hoist the mainsail using the main halyard, which exits the mast on the lower port side.

Note: Hoisting the mainsail is a two person operation. One person will be required to feed the mainsail in to the mast track while another hoists using the halyard (This will prevent the sail from pulling out of the track and jamming, which could cause luff rope damage.)

8. When the mainsail is fully hoisted, coil the halyard and store in the halyard bag on the underside of the genacker sock. (figure 55)



figure 55

9. Outhaul

1. Secure the velcro tack around the mast. (figure 56)

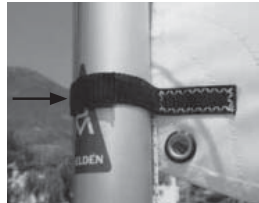

figure 56

2. Feed the plastic slug slide on the clew outhaul to the cut out on the top of the boom. (figure 57)

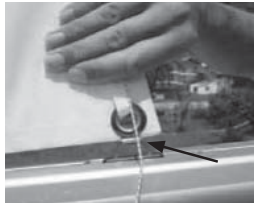

figure 57

3. The outhaul line (blue) is then passed through the eye in the sail (from port/left to starboard/right side) and anchored on the starboard/right side with a simple knot located in the slot formed in the boom end casting. (figure 59a) (figure 59b)

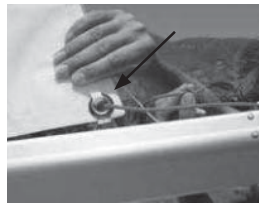

figure 59a

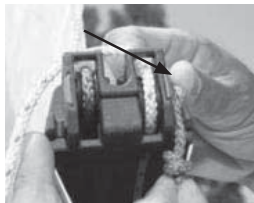

figure 59b

4. Outhaul tension is controlled using the blue rope, cleat and fairlead at the forward end of the boom. (figure 60)

10. Cunningham

1. Pass the rope at the end of the cunningham purchase system through the eye at the bottom of the mainsail luff (from starboard/right hand to port/left hand side).

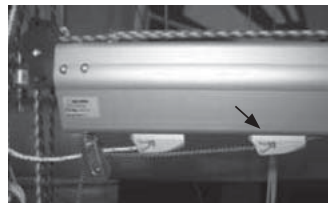

figure 60

2. Anchor the end of the cunningham purchase system by sliding a half hitch knot into mast track just below the gooseneck. (figure 61)



figure 61

3. Cunningham tension is controlled using the blue rope, the cleat and fairlead block is on the starboard side of the mast. (figure 62)



figure 62

11. Single Line Reefing

1. Rig the single line reefing.

2. Although single line reefing is only applicable to the Bahia sail, you will find a pocket at the forward end of the foot of the mainsail (port side) to tidy the loose end of the single line reefing system. (figure 63)

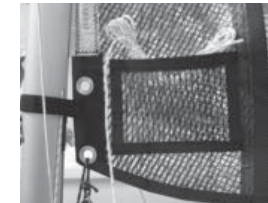

figure 63

3. Single line reefing tension is controlled using the white rope, cleat and fairlead at the forward end of the boom. (figure 64)

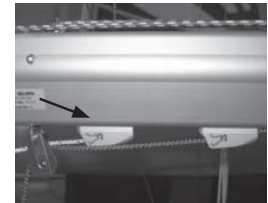
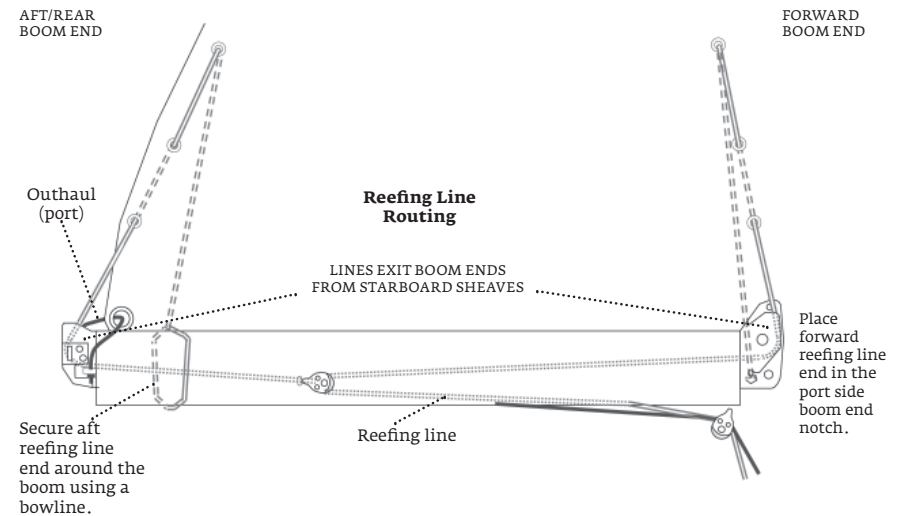

figure 64

12. Single Line Reefing Instructions



13. Single Line Reefing Method

1. Ease sheet and Gnav

2. Pull the reefline. The boom will angle up until all of the aft reefing line slack is taken in or Gnav travel limit is reached.

3. Ease the halyard and continue pulling the reefline. The boom outer end will move down towards horizontal.

4. When the reefline has finished pulling the clew and tack down hard, cleat it off.

5. Adjust halyard tension and adjust the Gnav and sheet.

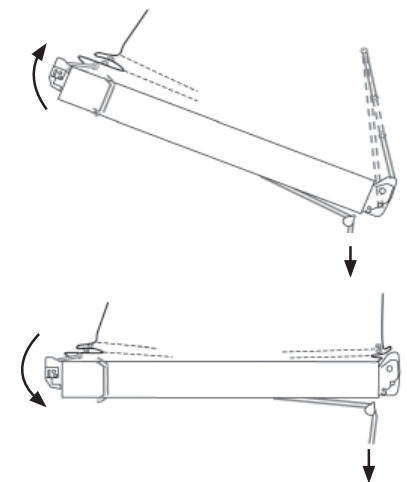

14. Rudder and Centerboard

The pin goes through from the top of the rudder stock and through both sets of gudgeons. This must be secured with the split ring below the bottom gudgeon. (figure 65)

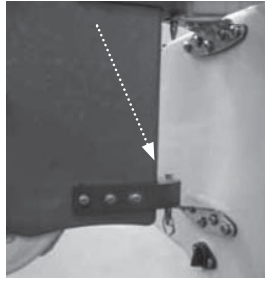

figure 65

The centerboard friction device can be used to adjust the tension on the side of the centerboard that holds the centerboard down whilst sailing. This is placed through the two holes on the top of the centerboard case. To tighten, a pozi drive screwdriver is used to tighten or loosen as required. Both sides are adjusted. To tighten, screw through all four holes clockwise and opposite to loosen. (figure 66)

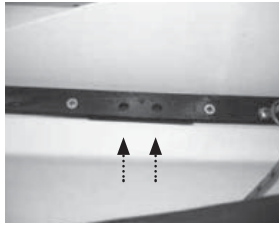

figure 66

Before you go sailing

1. Check you are wearing suitable clothing and safety equipment for the conditions and time of year.
2. Always wear a buoyancy aid or life jacket
3. Make sure a third party knows where you are sailing and how many of you are sailing.
4. Check the weather forecast.
5. Check the time of high and low tides if applicable.
6. Seek advice on the local conditions if you are sailing in a new area.
7. Always check the condition of your craft before setting off.
8. **Check for overhead cables when rigging, launching and recovering.**
9. The use of a LaserPerformance supplied Bahia mast head float is highly advisable. *(This device will assist in the prevention of complete inversion in the event of capsizing).*

Launching

1. Raise the mainsail with the boat facing into the wind.
2. Launch the boat using the appropriate launching trolley.
3. Take the boat into the water with the bow facing into the wind.
4. Ensure that there is enough water to float the boat off the trolley/dolly.
5. One person should hold the boat while the other gets in and prepares to set off.
6. When there is enough water below you, lower the centerboard and rudder fully.
7. Clear the rudder downhaul in the cleat on the tiller and ensure that the wing nut on the side of the rudderstock is tight.

On the water

1. Conform to the sailing rules of the road.
2. Look out for changing weather conditions.
3. Never sail beyond your ability or that of your crew. Ensure that you and your crew can cope with any changes in the wind conditions.
4. Be competent in your sailing skills and righting techniques.

15. Launching, rowing, & basic safety on the water

A. Rowing (Option)

The Bahia rowlocks have on an asymmetrical lower end that engages with a keyway in the bottom of the rowlock socket. This feature is designed to prevent rowlock disengagement and/or loss whilst rowing. When not in use the rowlock can be stored in the center console hatch compartment. (figure 67)



figure 67

The storage box lid is turned upside down and is used as a seat whilst rowing. The centerboard should be up whilst rowing. (figure 68)



figure 68

16. Engine, Bracket and Storage Box (Optional extra)

The engine bracket is fitted by simply locating the bracket's pin into the bush in the Bahia transom top. (figure 69) This is a push fit.



figure 69

It is then secured by the eye bolt through the engine bracket into the insert in the back of the boat. This will have a plastic thumb screw cover which will need to be unscrewed and kept in a safe place. (figure 70)



figure 70

.....
Note: BE CAREFUL NOT TO CROSS THREAD THE EYE BOLT INTO THE INSERT WHEN FITTING.
.....

The engine should be secured to the eye bolt with a piece of rope. This rope should be as long as possible without fouling the prop when the engine is running. A short lanyard can be a hazard if the engine comes loose from the bracket as the engine can turn over and the prop will be in the air. (figure 71)



figure 71

MAXIMUM recommended engine capacity 3.3 HP

The storage box is secured in by two eye bolts, one on either side. Care must be taken when screwing in the eye bolts to avoid cross threading.

The engine must be secured to BOTH eye bolts in the box to avoid the engine coming loose in the event of capsizing.

The lid has a securing lanyard and can be tightened by applying pressure to the lid when cleating the lanyard. The lid is a useful seat for use with the outboard. (figure 72)



figure 72

Care, Maintenance and Service of your LaserPerformance Product

Before rigging your boat, read and familiarize yourself with the rigging manual. Failure to adhere to these guidelines could invalidate your warranty.

Maintenance

- Keep the equipment clean by frequently flushing with fresh water. In corrosive atmospheres, stainless parts may show discoloration/brown staining around screw holes and rivets. This is not serious and can be removed with a fine abrasive.
- Excess water should be removed from the hull.
- Ropes, rigging and fittings should be checked at regular intervals for wear and tear, including winch gear.
- All moving parts should be lightly lubricated to avoid jamming, i.e., McLube, dry Teflon or a dry silicone based spray. Do not use oil.
- Inspect shackles, pins and clevis rings and tape up to stop snagging sails, ropes and clothing and to prevent them from coming undone.
- When refastening screws do not over tighten as this may strip the thread and do not reuse Nyloc nuts more than three times.
- Damaged or worn parts should be replaced.
- Sails should be thoroughly washed down with fresh water, dried and stored in a dry place.

Trailers and Trolleys/Dollies

- It is highly recommended that a trolley/dolly is used to launch and recover your boat. Dragging your hull up onto a beach or slip way will wear away the gel coat or polyethylene and damage the boat. Also, the hull should not be left on a pebble beach as the hull skin could be dented.
- Trailers should be rinsed with fresh water and checked at regular intervals. It is recommended that trailers be serviced annually. The trailer and road base should never be immersed in water.
- Trailers and trolleys supplied by LaserPerformance are designed to transport the hull in the best possible manner to avoid damaging the hull. For instance, LaserPerformance does not recommend support hulls on rollers except on the keel line and only where there is a reinforced keelson. We also recommend gunwale hung trolleys for our smaller products. Hulls supported by a trolley bunk or wide strap must have the ability to drain water away from the hull. Trolley bunks padded with carpet or foam can cause blistering in the gel coat and changes to the hull color. Please do not transport your LaserPerformance product on a trailer or trolley that has not been specifically designed for the product. Hulls damaged through using an incorrectly designed or wrongly set up trailer or trolley are not covered under warranty.
- When securing your boat to a trailer for transport be very careful that ratchet straps and ropes are not over tightened and that there is sufficient padding under the strap or rope to prevent the hull/deck from being damaged through abrasion or pressure.
- Top covers must not be allowed to “flap” when driving at speed. This can abrade the surface of the hull and damage it. It is recommended if you are towing and plan to use your top cover that an under cover is fitted first to prevent cover flap damage to the top sides of the hull.
- Repairs to the polyethylene or GRP hulls should be undertaken by persons with the relevant equipment and skills. Contact LaserPerformance for advice.

Storage

- Your boat should always be tied down securely to the ground when not in use.
- UV light will cause fading to some components and fittings. A cover is recommended to reduce the UV degradation.
- Do not leave the rig under tension when not sailing or during storage.
- Care must be taken to support the hull adequately if storing on racking or similar. Any sustained point loading could permanently dent or distort the hull.
- Under covers for LaserPerformance products should be produced from a breathable or semi breathable fabric to allow moisture to evaporate away from the hull. This is essential to prevent damage to the hull skin. Also, the hull should never be left in the under cover wet or damp. A combination of moisture and heat over an extended period can also damage the hull. The under cover is designed to protect the hull when being transported and should be removed when the hull is being stored. Typical damage includes small bubbles or blisters, excessive print through of glass reinforcement, foam or wood and color change.
- Rudders and centerboards must never be stored wet in carry/combo bags. This can cause blistering, print through and warpage.
- All our GRP products are designed to be dry sailed. In other words stored on dry land. If you intend to leave your boat on a mooring for any length of time it is essential that you apply an osmosis barrier coat. LaserPerformance can recommend a suitable product.

On Water

- When wearing a trapeze harness, take particular care when climbing on to the centerboard and back into the boat after a capsized. The trapeze harness hook could easily damage the hull or deck.

On Water Towing

- Towing your LaserPerformance product at high speed (10 – 20 knots) behind a rib or power boat can seriously damage the hull. Boats damaged in this manner are not covered by the warranty. LaserPerformance recommends a maximum towing speed of 6 knots.

Owner Information

hull identification number	
<hr/>	
purchased from	date of purchase
<hr/>	
contact name	phone #
<hr/>	
address:	
<hr/>	
city / state / county	zip / postal code
<hr/>	
hull color: sail #:	
<hr/>	
registration information (if applicable)	
<hr/>	
trailer vin #	
<hr/>	
license plate number	
<hr/>	
registration number	state / county registered in
<hr/>	
insurance information	
<hr/>	

LaserPerformance equips our Bahia with the highest quality parts available. We partner with key suppliers to develop top of the line dinghy equipment so your boat will perform at the highest level possible when sailed with the factory supplied rope, sails and hardware. Shop online at laserperformance.com or at an authorized LaserPerformance dealer to be sure you are getting genuine LaserPerformance parts and accessories. Visit www.laserperformance.com to find your local dealer.



SAILMARKET, S.L.
NARCIS MONTURIOL 27
08339 VILASSAR DE DALT
BARCELONA - SPAIN

TEL 00 34 93 753 36 02
FAX 00 34 93 753 37 00
www.sailmarket.es

sailmarket@sailmarket.es

All rights reserved. ©2008 LaserPerformance.
LaserPerformance and associated logos are
trademarks. Laser, SB3, Sunfish, and Dart
are trademarks used under license.
LaserPerformance reserves the right to make
design and/or specification changes to any
of their products as part of their continuous
development program.